

FULL FULL BUNK - 0388

Part List :

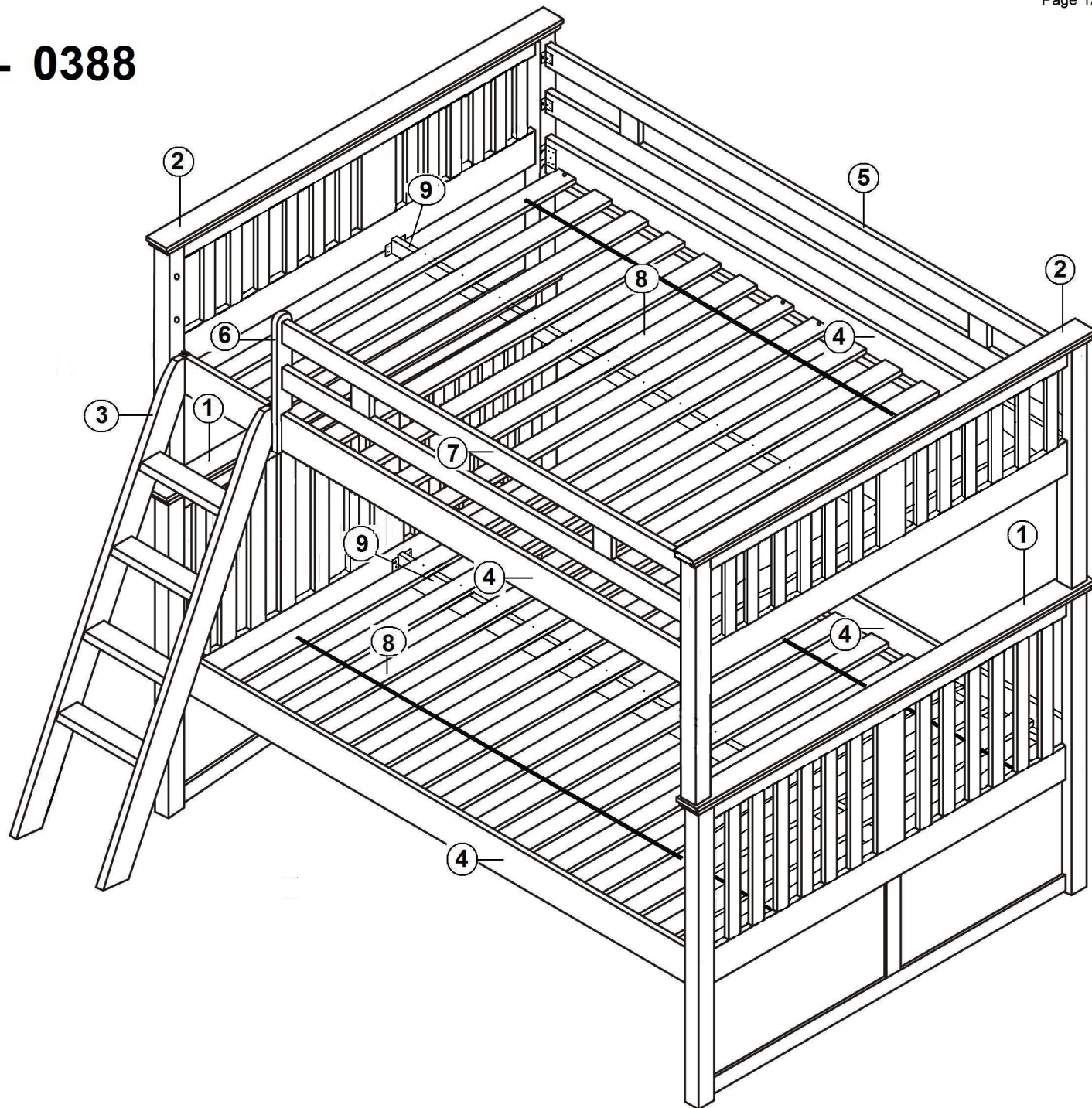













Item	Description	Qty
1	Bottom Headboard	2 pcs
2	Upper Headboard	2 pcs
3	Ladder	1 pc
4	Side Panel	4 pcs
5	Long Guard Rail	1 pc
6	Guard Rail Support	1 pc
7	Short Guard Rail	1 pc
8	Slat	2 sets
9	Center support	2 pcs



Assembly Instruction

0388

Hardware List :

Item	Description	Qty
A	JCBC M6 x 60 	2 pcs
B	JCBC M6 x 30 	6 pcs
C	Allen key M4 	1 pc
D	Barrel nut 	2 pcs
E	CSK screw M4 x 25 	112 pcs
F	Metal Pin 	4 pcs
H	Ladder Hook (for Short Ladder) 	4 pcs
H	Ladder Hook (for Long Ladder) 	2 pcs
I	JCBB M8 x 25 	16 pcs
J	Allen key M5 	1 pc
K	CSK screw M4 x 32 	2 pcs
L	CSK screw M4 x 16 	28 pcs
M	"L" Bracket 	6 pcs
N	"U" Bracket 	4 pcs

DO NOT TIGHTEN SCREWS BEFORE ALL PARTS ARE FULLY ASSEMBLED !!

Step 1

Bottom Bunk

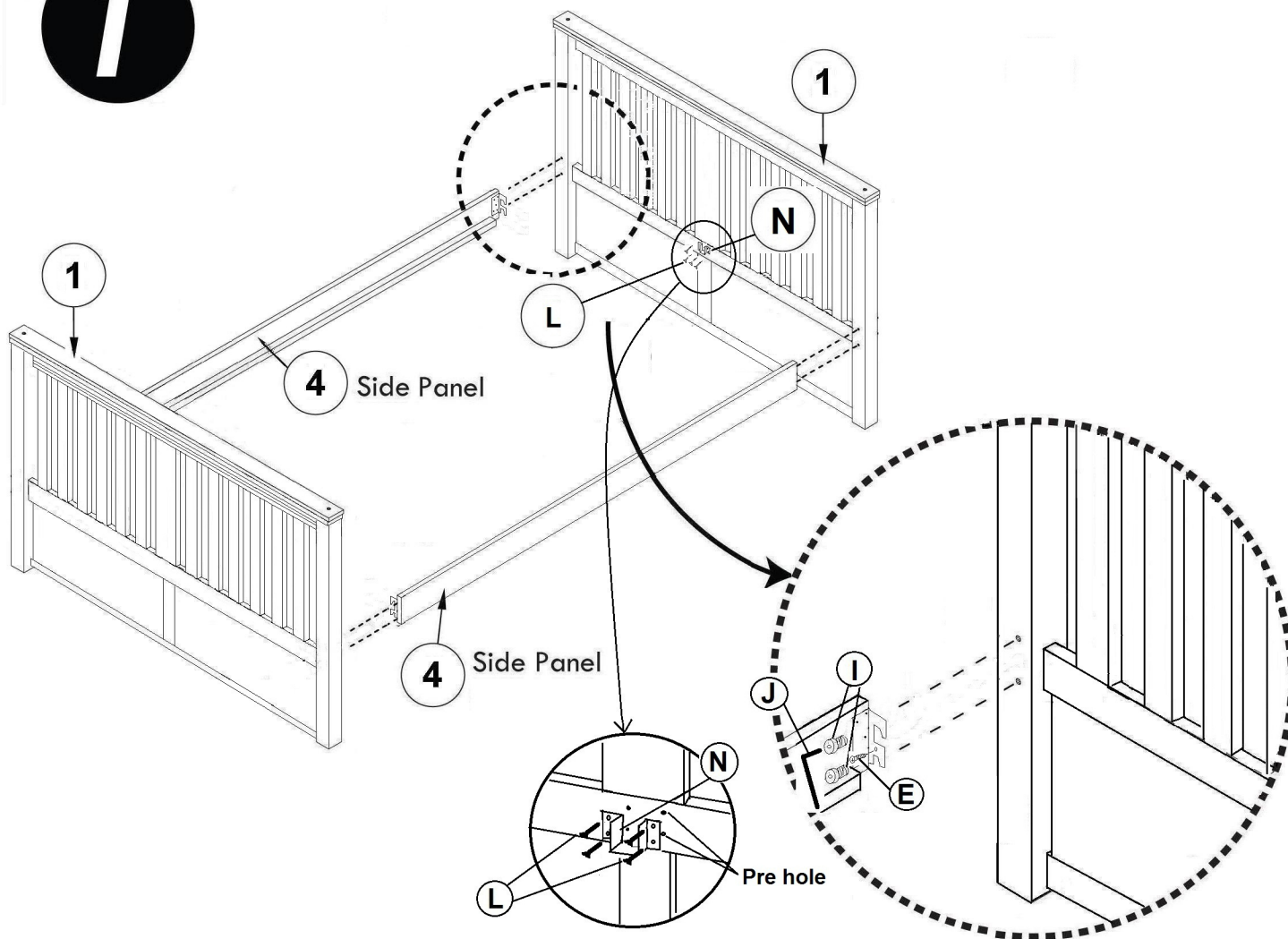

Step 2

Upper Bunk

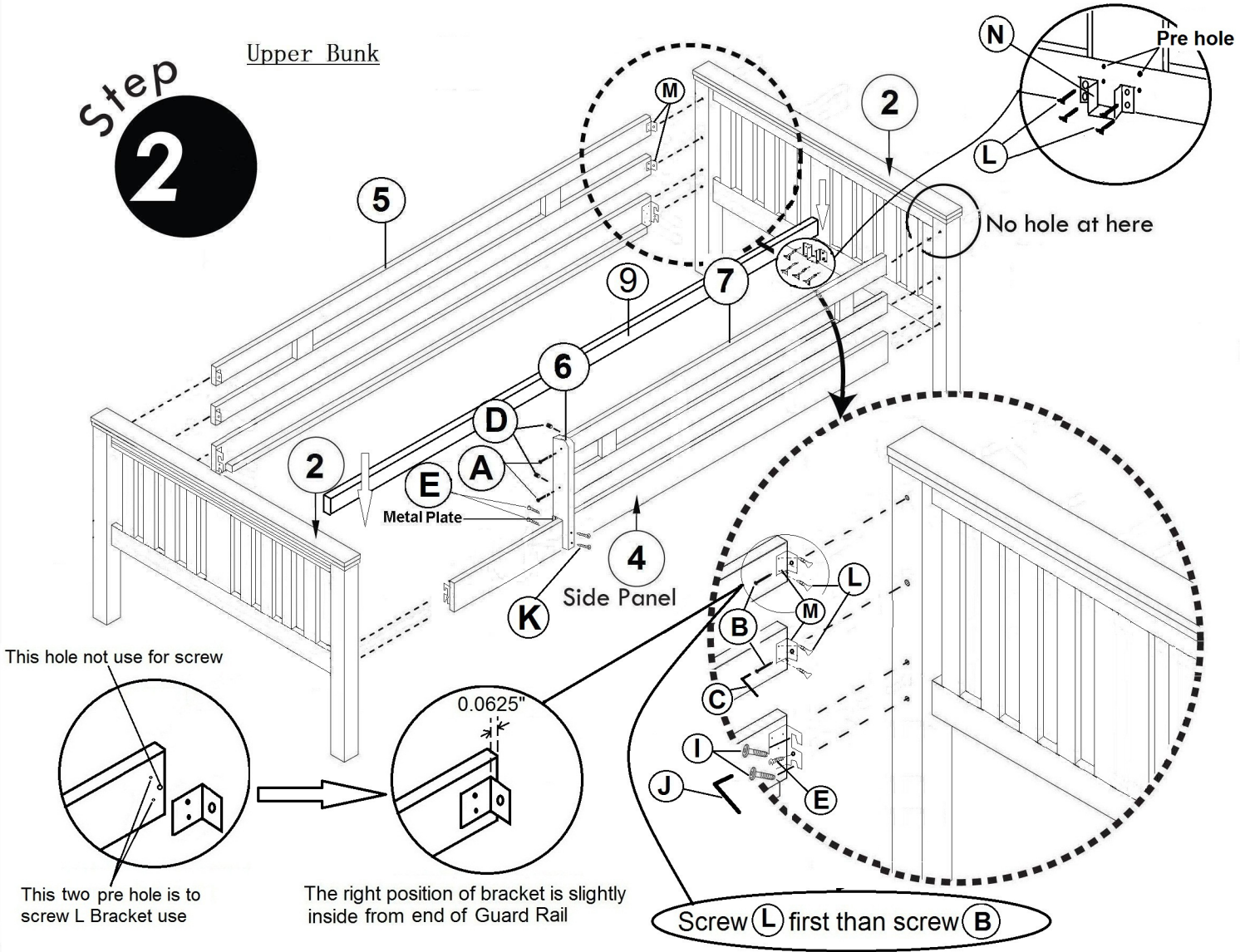

Step 3

Bottom Bunk

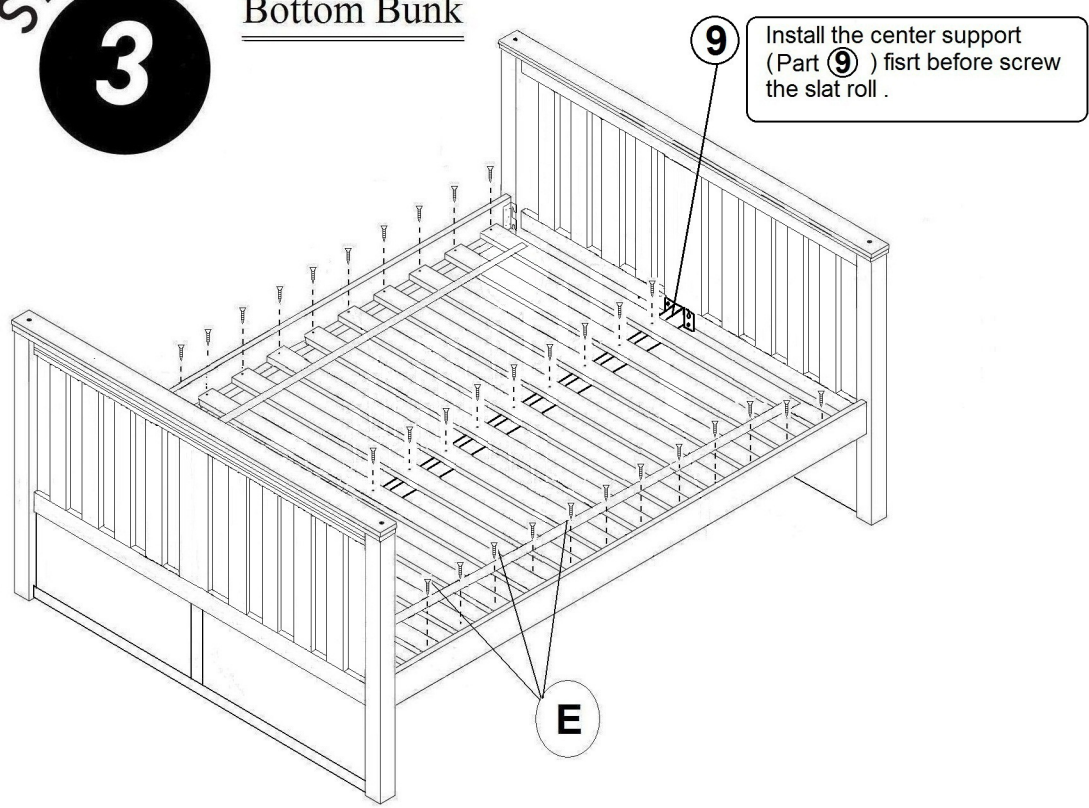

0388

Step 4

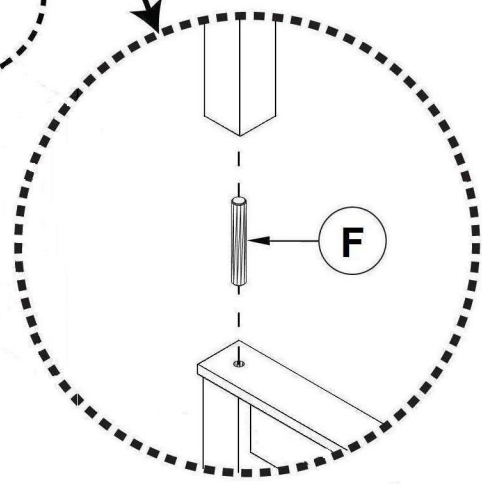
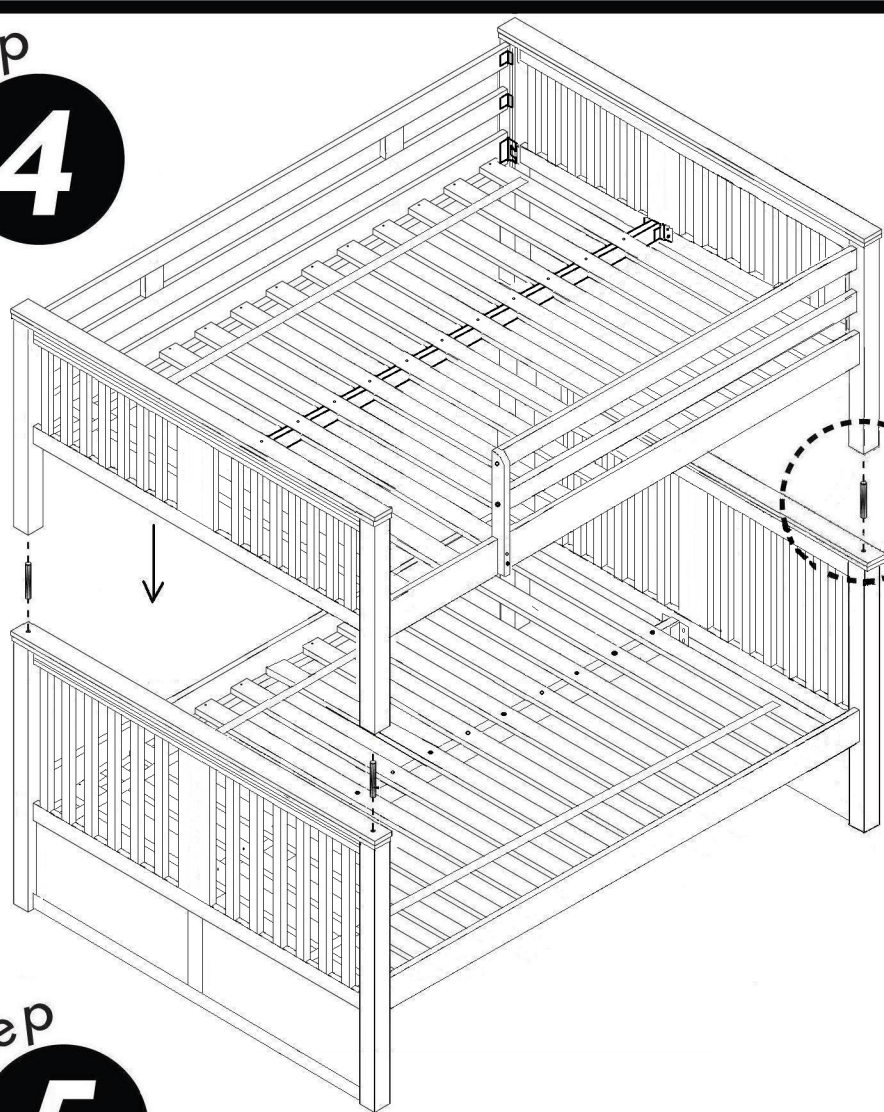

Step 5

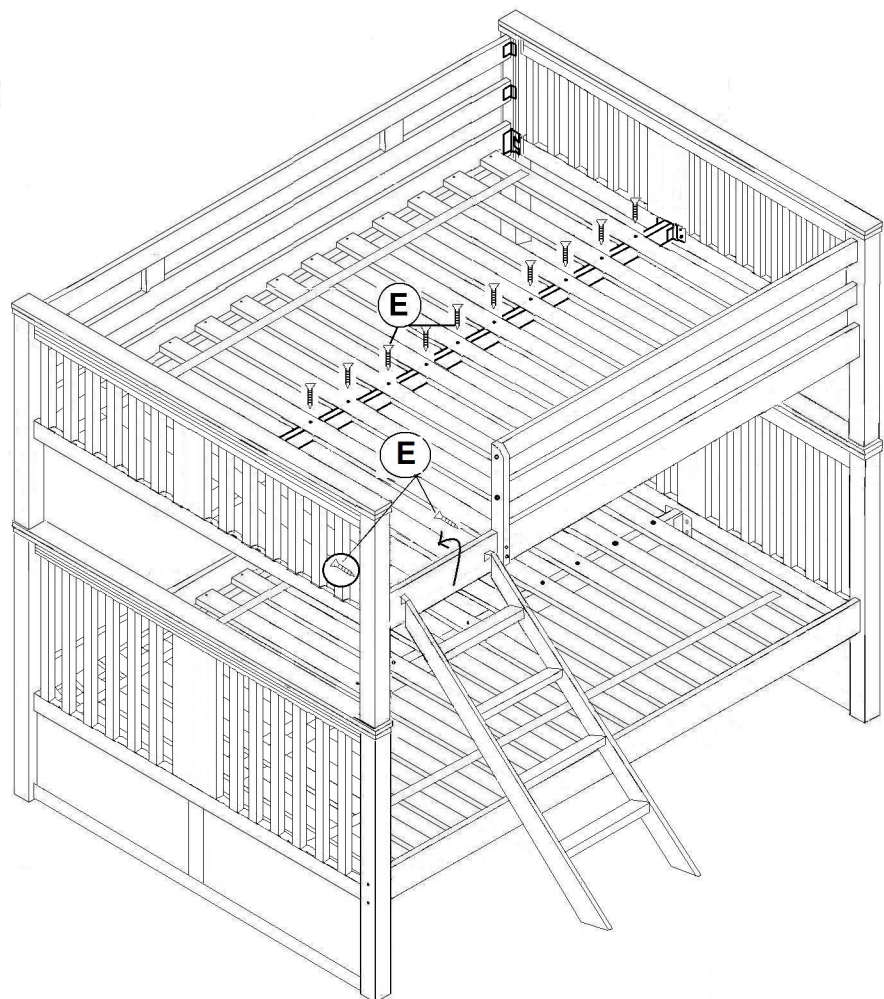
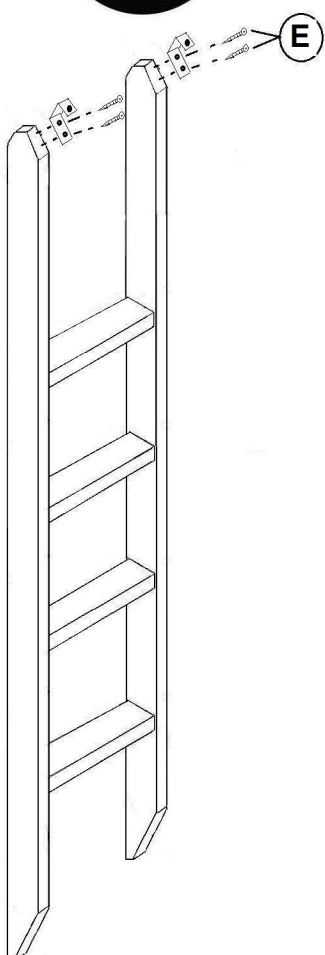

Step 6