

0171 TWIN QUEEN BUNK

Part List :

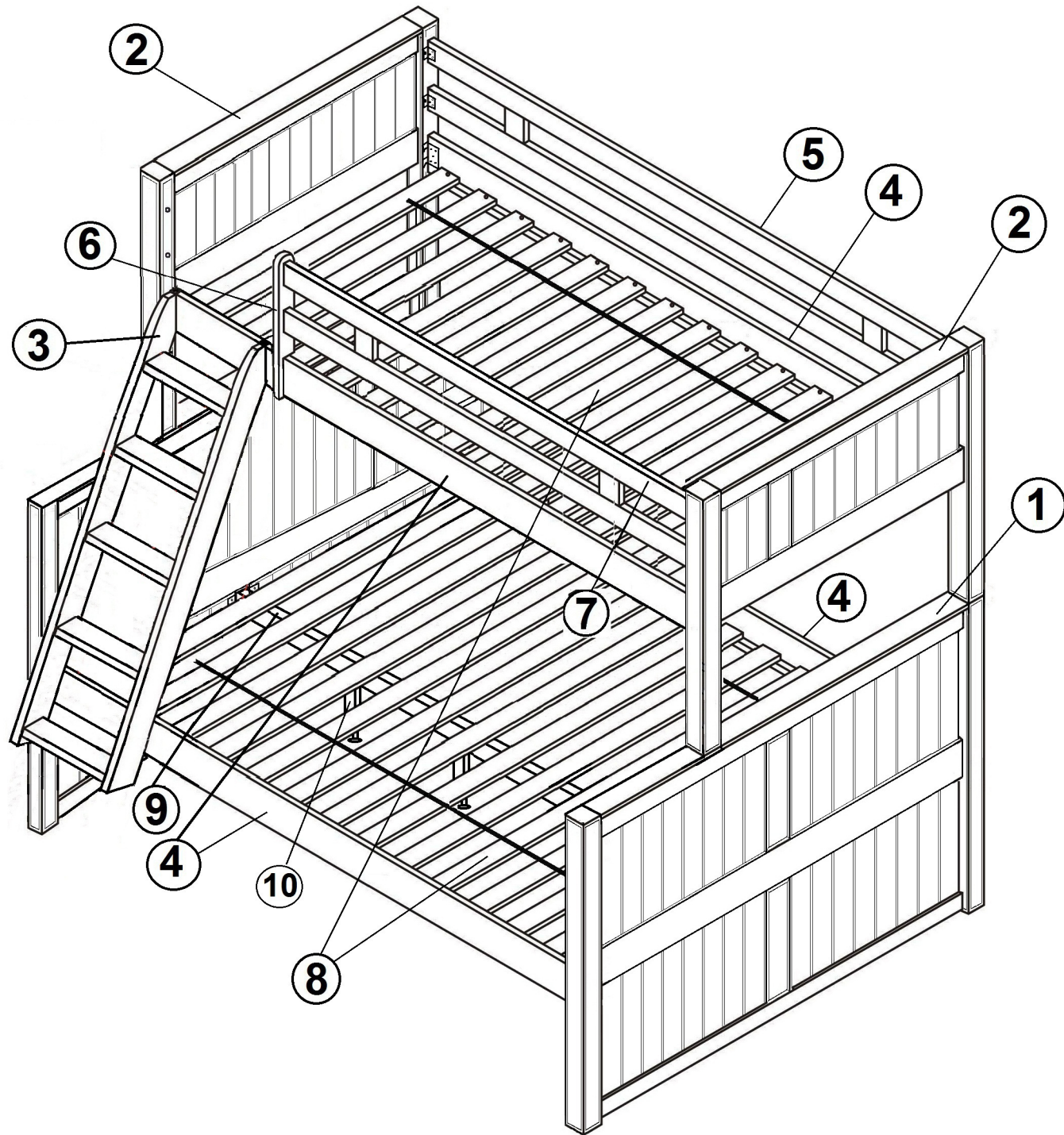













Item	Description	Qty
1	Bottom Headboard	2 pcs
2	Upper Headboard	2 pcs
3	Ladder	1 pc
4	Side Panel	4 pcs
5	Long Guard Rail	1 pc
6	Guard Rail Support	1 pc
7	Short Guard Rail	1 pc
8	Slat	2 sets
9	Center Support	1 pc
10	Leg Support	3 pcs



Assembly Instruction

0171

Hardware List :

Item	Description	Qty
A	JCBC M6 x 60 	2 pcs
B	JCBC M6 x 30 	6 pcs
C	Allen key M4 	1 pc
D	Barrel nut 	2 pcs
E	CSK screw M4 x 25 	107 pcs
F	Metal Pin 	4 pcs
H	Ladder Hook (for Short Ladder) 	4 pcs
H	Ladder Hook (for Long Ladder) 	2 pcs
I	JCBB M8 x 25 	16 pcs
J	Allen key M5 	1 pc
K	CSK screw M4 x 32 	8 pcs
L	CSK screw M4 x 16 	20 pcs
M	"L" Bracket 	6 pcs
N	"U" Bracket 	2 pcs
O	Wood Cap 	8 pcs

DO NOT TIGHTEN SCREWS BEFORE ALL PARTS ARE FULLY ASSEMBLED !!

Step 1

Bottom Bunk

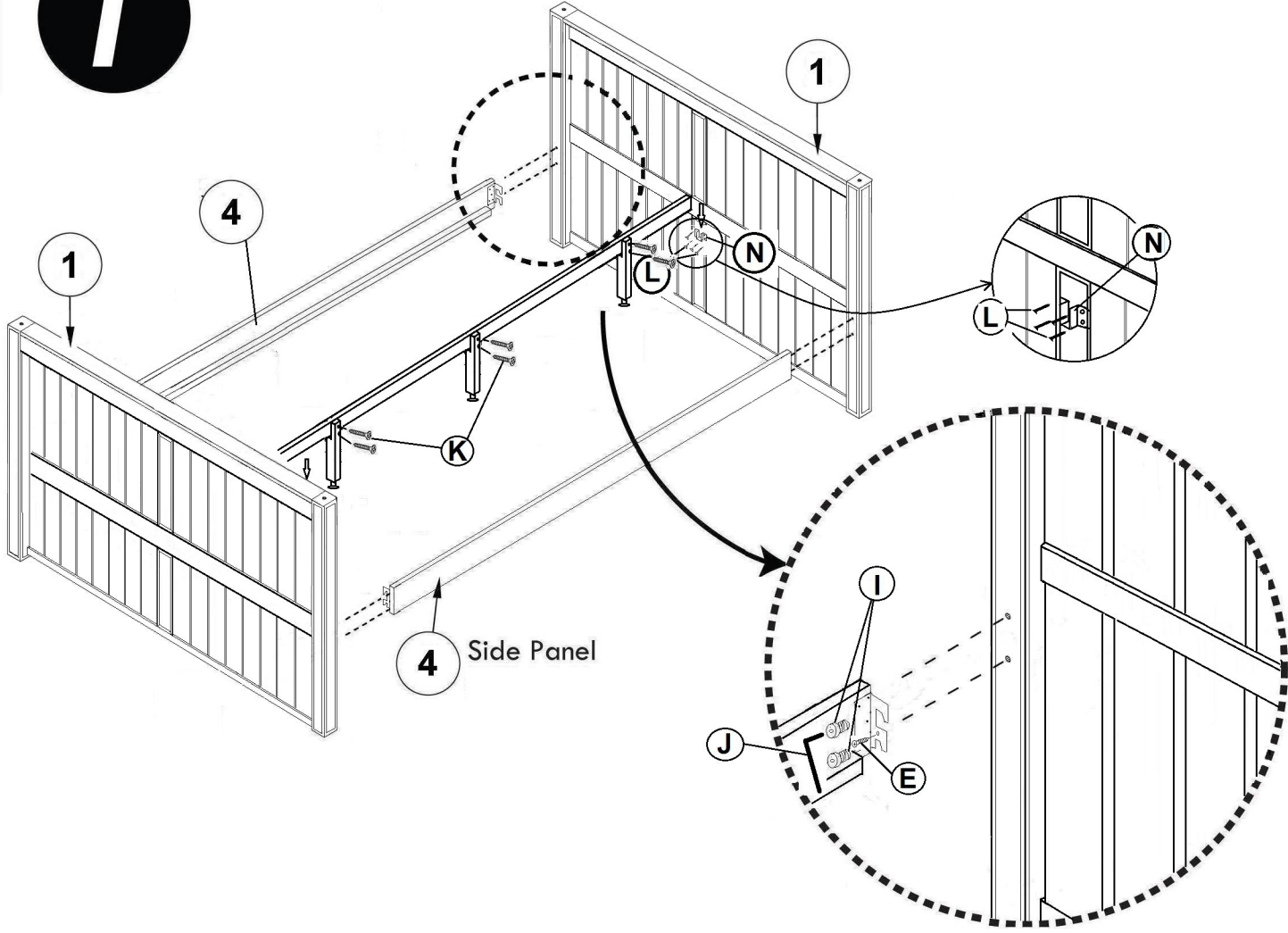

Step 2

Upper Bunk

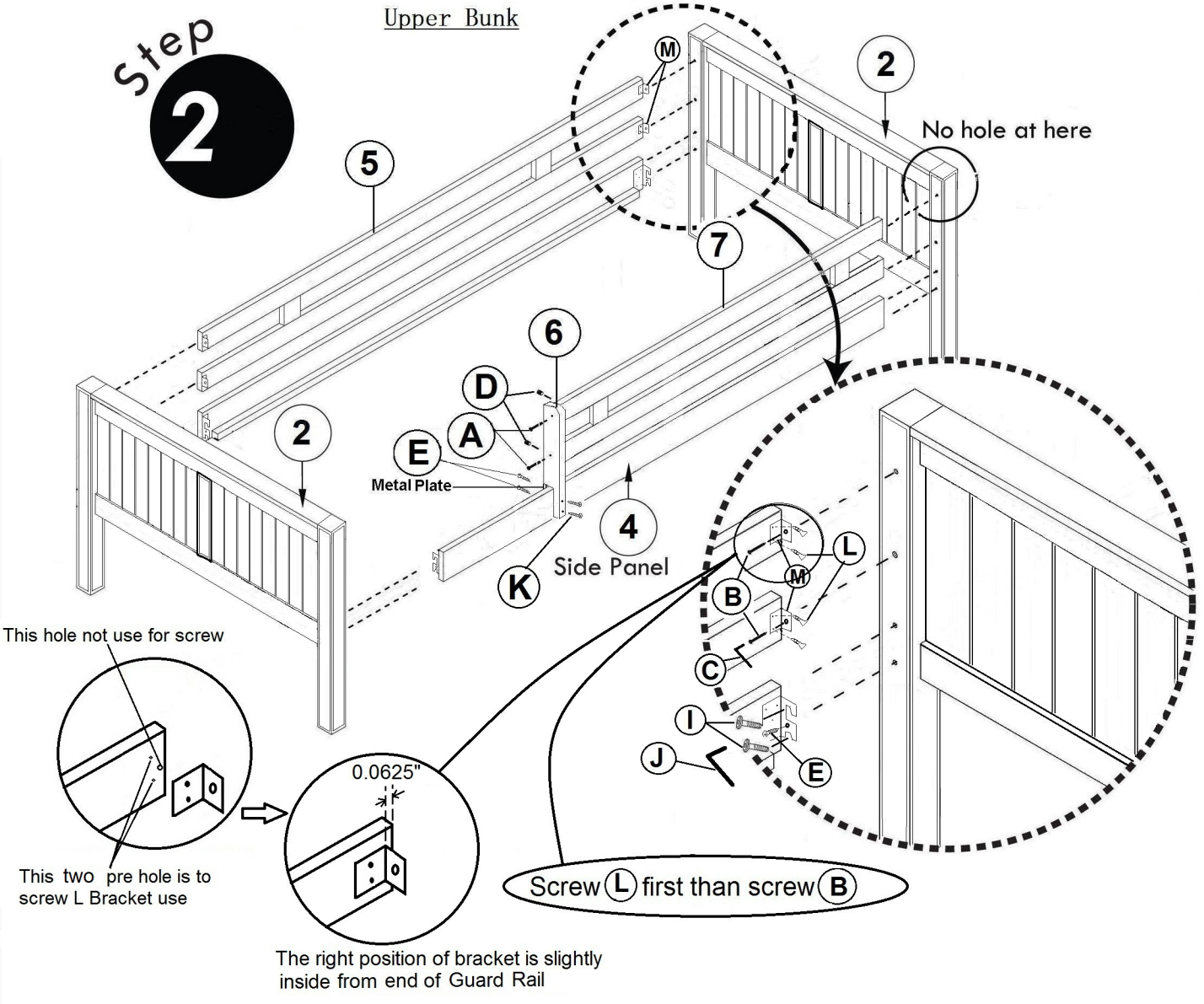

The right position of bracket is slightly inside from end of Guard Rail

Screw L first than screw B

Step 3

Bottom Bunk

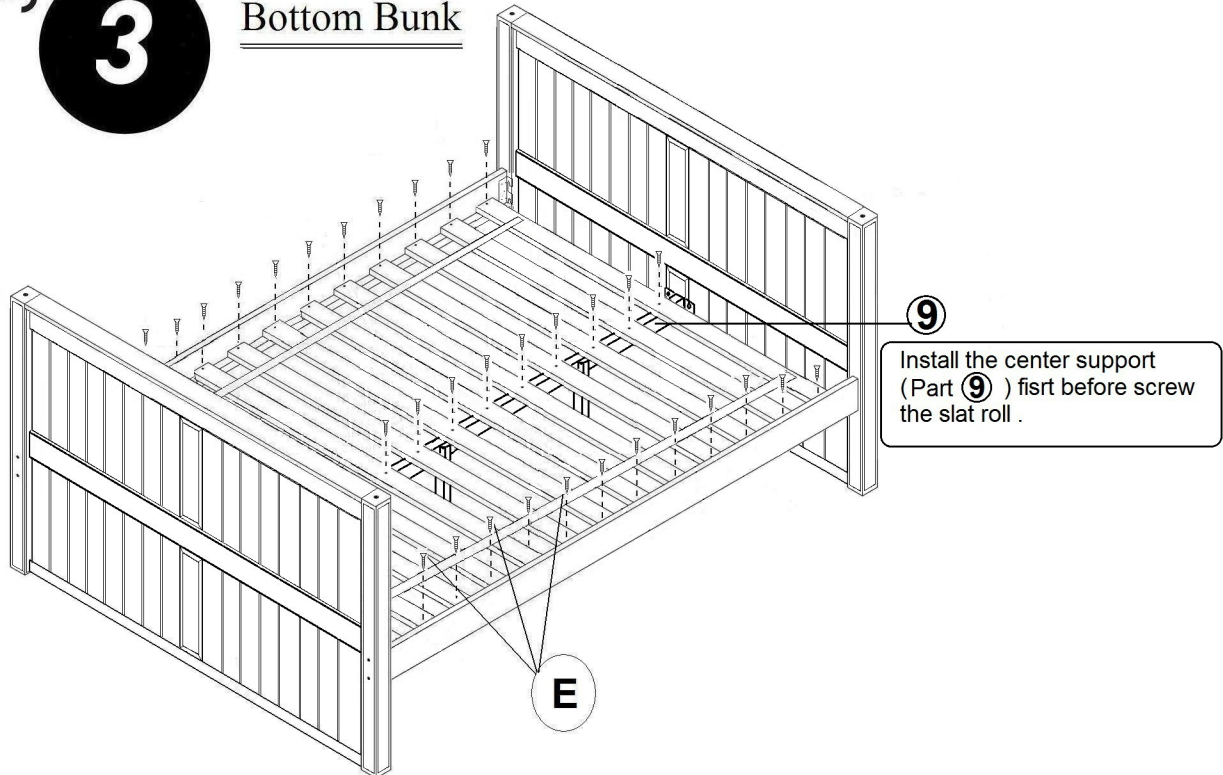

Install the center support (Part 9) first before screw the slat roll .

Step 4

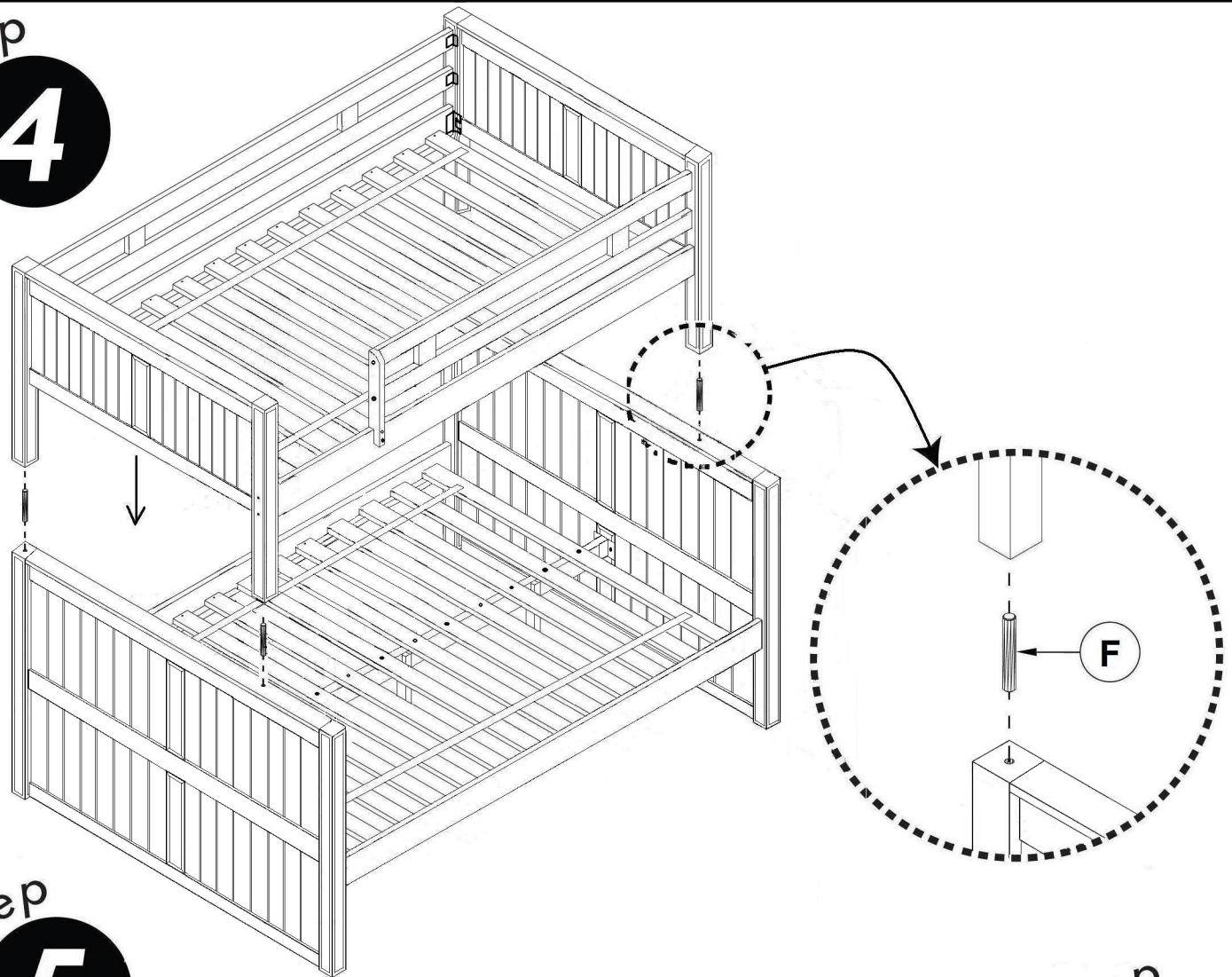

Step 5

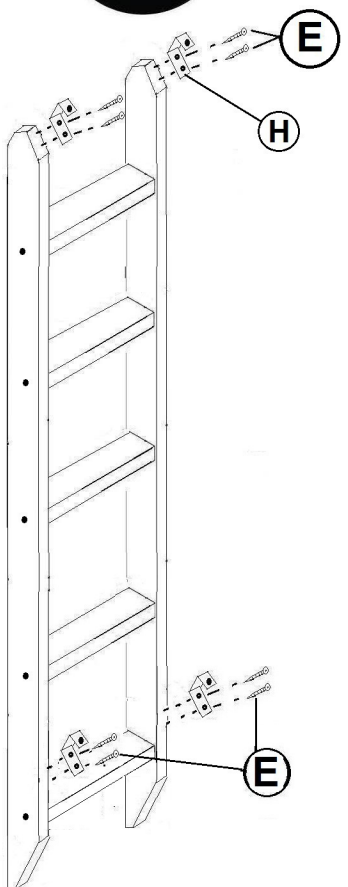

Step 6

