

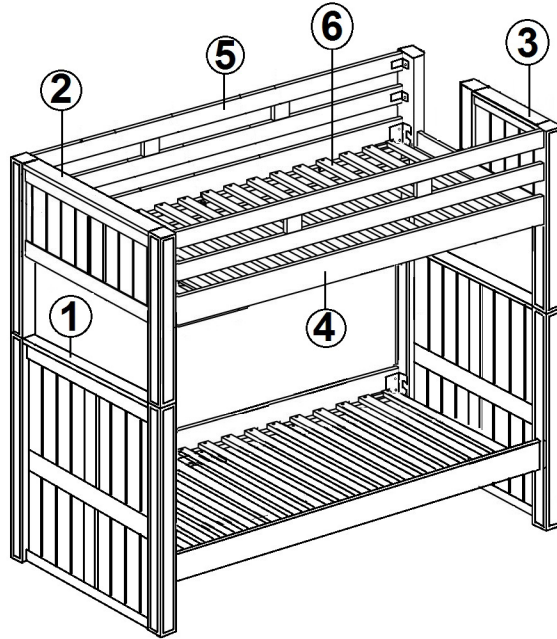









0161-C

Part List :

Item	Description	Qty
1	Bottom Headboard	2 pcs
2	Upper Headboard	1 pc
3	Opening Headboard	1 pc
4	Side Rail	4 pcs
5	Long Guard Rail	2 pcs
6	Slat	2 sets



Hardware List :

Item	Description		Qty
B	JCBC M6 x 30		8 pcs
C	Allen key M4		1 pc
E	CSK screw M4 x 25		72 pcs
F	Metal Pin		4 pcs
I	JCBB M8 x 25		16 pcs
J	Allen key M5		1 pc
L	CSK screw M4 x 16		16 pcs
M	"L" Bracket		8 pcs
N	Wood Cap		9 pcs

DO NOT TIGHTEN SCREWS BEFORE ALL PARTS ARE FULLY ASSEMBLED !!

Step
1

Bottom Bunk

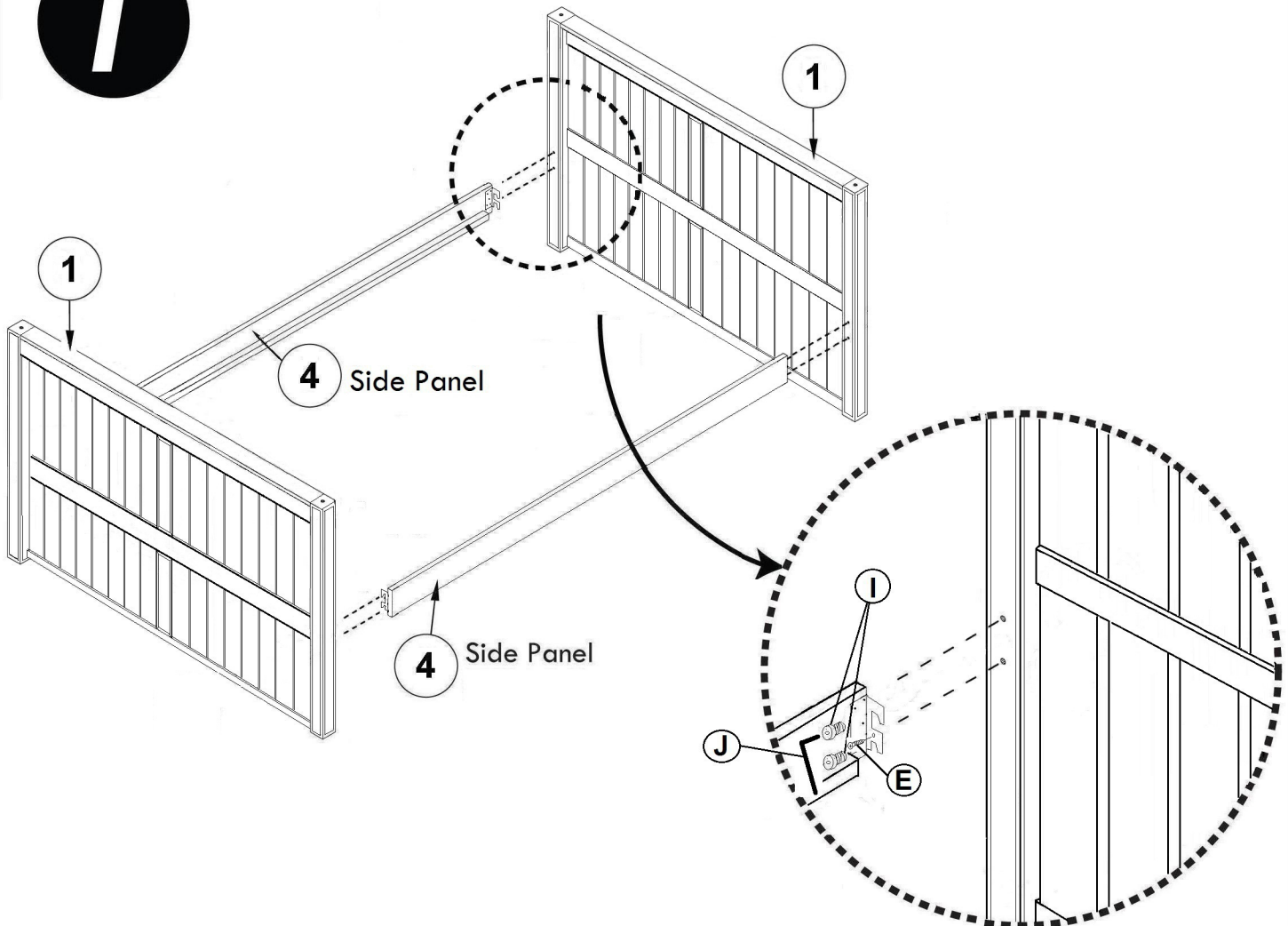

Upper Bunk

Step 2

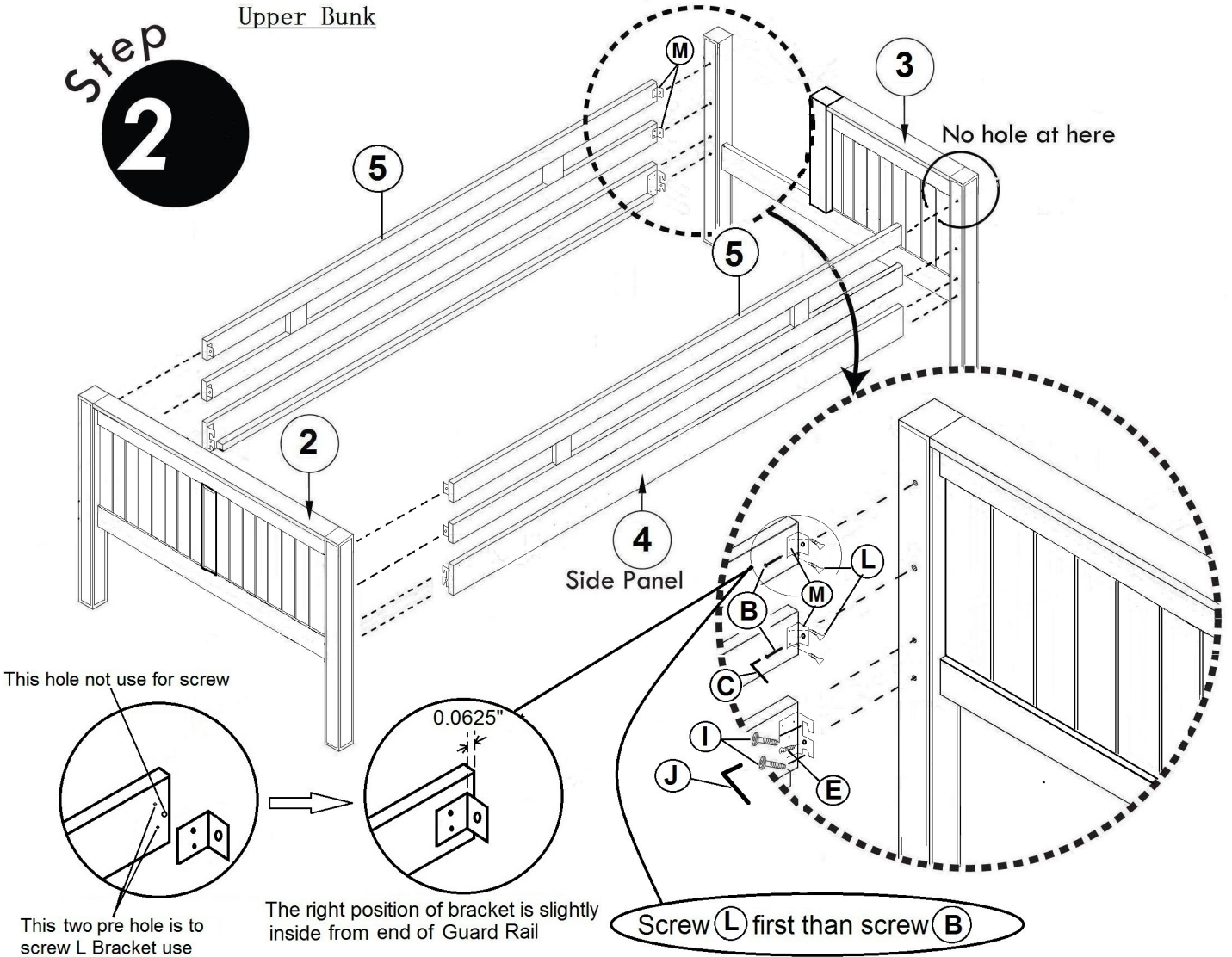

Bottom Bunk

Step 3

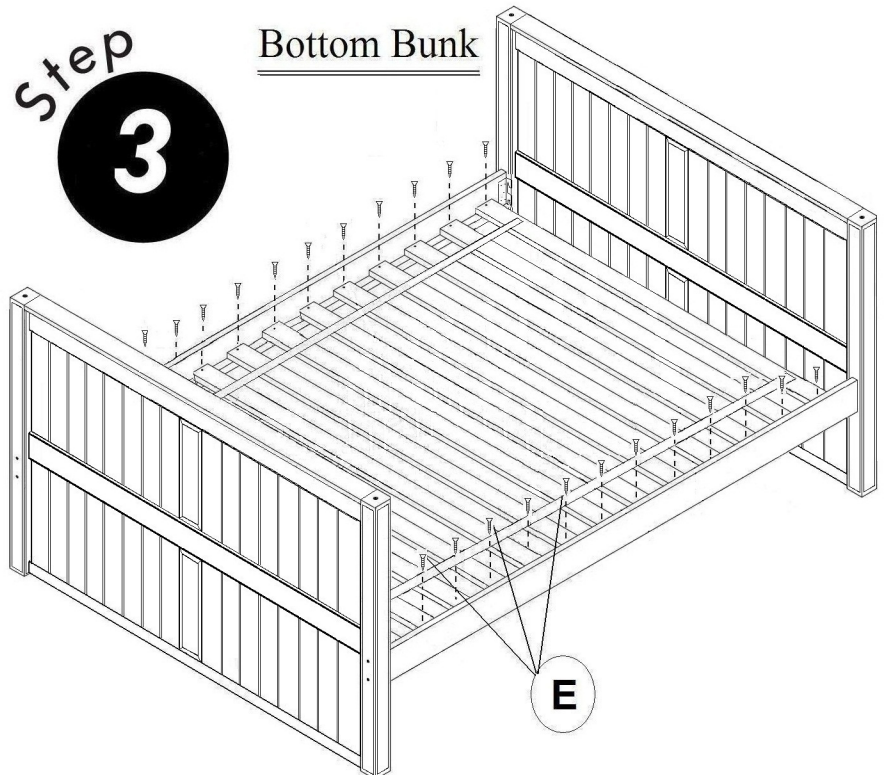

Step
4

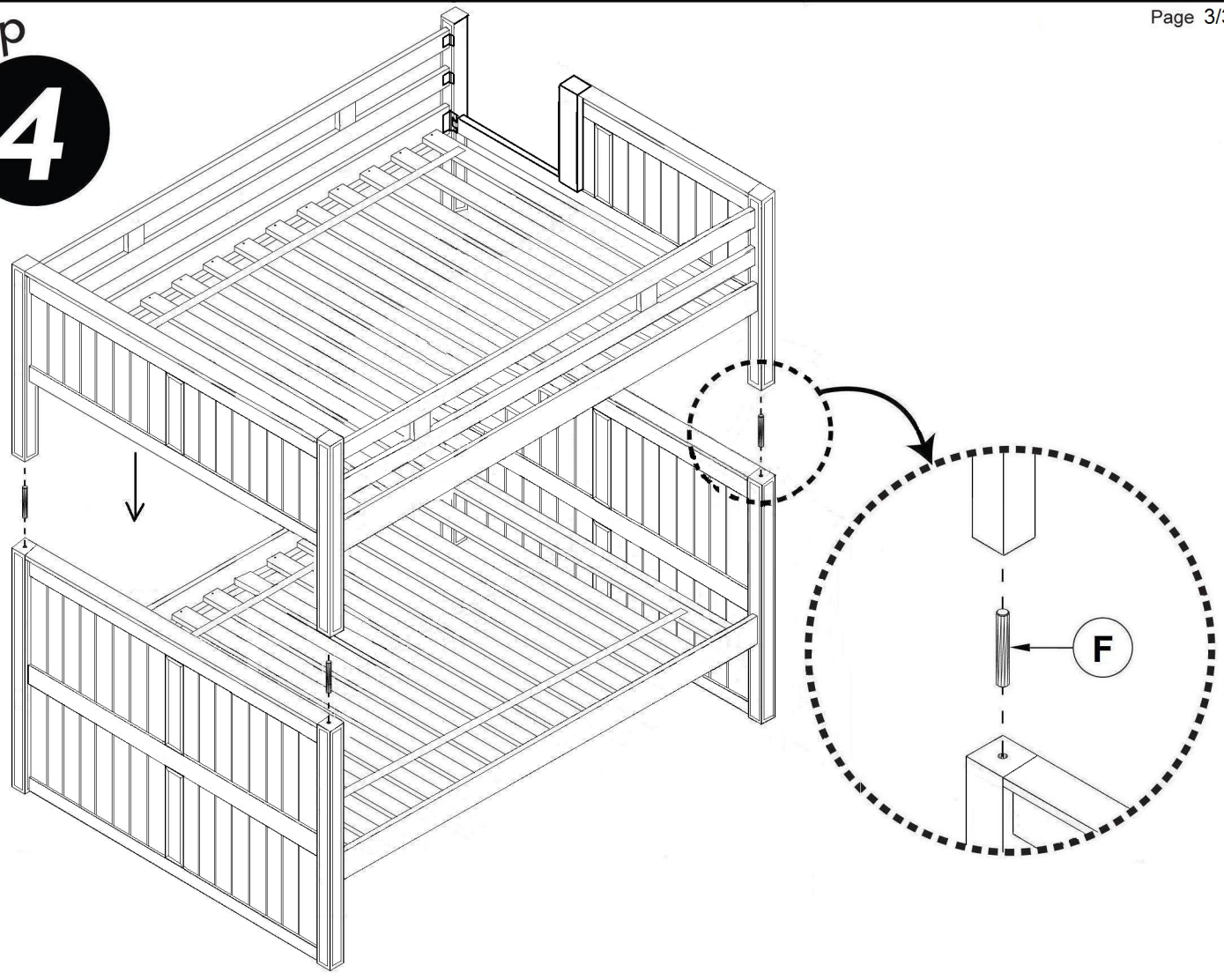

Step
5

